



N O V A S A R C H I T E C T U R A L

TOILET PARTITION

2016





Ultima Series

About Ultima

- Ultima toilet partition fittings are a sophisticated, stylish and durable collection for prestigious projects.
- Ultima is ideally suited to prestige office and hotel environments where superior quality and design are demanded.
- Ultima is primarily manufactured from Stainless Steel (304 grade) for ultimate durability, strength and sanitation.
- Complies with Building Code of Australia F2.5(B) Construction of Sanitary Compartments (using Novas 350601).
- Architecturally designed with clean lines and modern curves to integrate with today's styling.

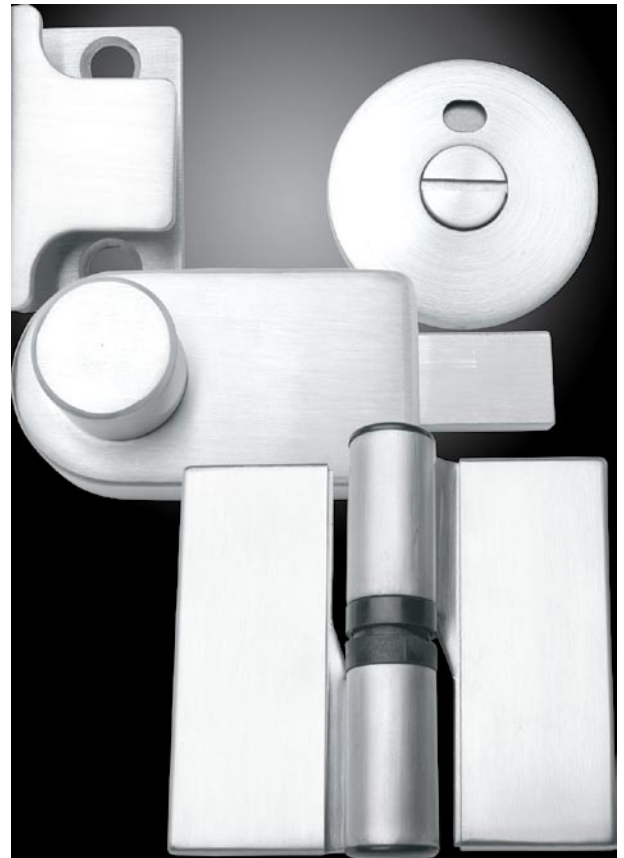

Gravity Hinge

The Novas Gravity Hinge allows the door to be removed from outside the compartment in case of emergencies.

Gravity Hinge-Concealed

Product Code 370109L (LH, One Pair)
370109R (RH, One Pair)

Fixing Screw Fix

Finish SSS, PSS

Description Concealed fixing with unique Stainless Steel cover plates.
Quality Gravity Hinge manufactured in Stainless Steel (304 Grade).
Features high wearing compound material for hinge connection.

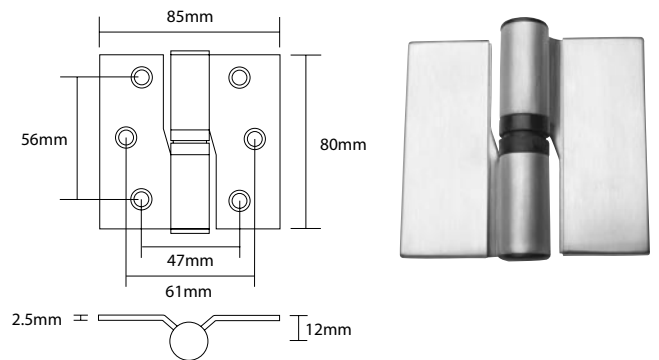

Bumpers

Bumper-Standard

Product Code 350201

Fixing Screw Fix

Finish SSS, PSS,

Description Stainless Steel (304 grade).

Rubber stop insert.

Supplied with mounting screws.

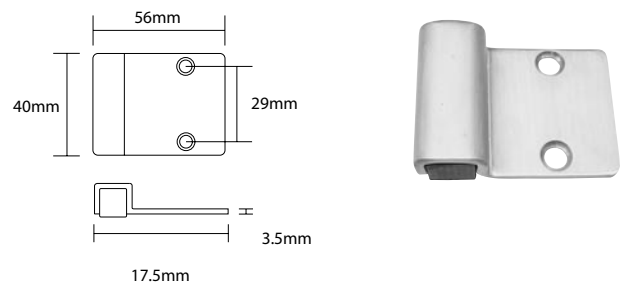



Ultima Series

Turnbolt and Staples

Turnbolt

Product Code 370401
Fixing Bolt Through
Finish SSS, PSS
Description Turnbolt with smooth latching action.
Concealed bolt through fixture.
Manufactured in Stainless Steel (304 grade)

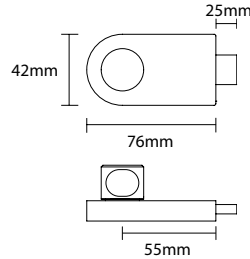

Ambulant Turnbolt

Product Code 370402
Fixing Bolt Through
Finish SSS, PSS
Handed Left Hand, Right Hand
Description Complies to AS 1428.1.2009 clause 16.3
Surface mounted and concealed fix
Lift off staple for emergency access
Manufactured in Stainless Steel (304 grade)

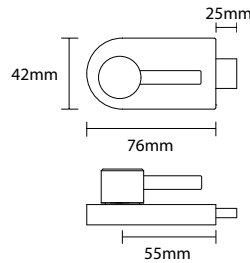

U Shaped Staple

Product Code 350601
Fixing Screw Fix
Finish SSS, PSS
Description Stainless Steel (304 grade).
Supplied with mounting screws.
Allows unrestricted lift-off of door in case of emergency.
Heavy duty construction for commercial applications.

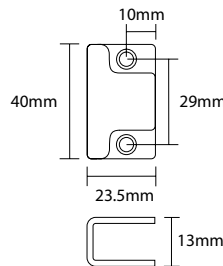



Ultima Series

Coat Hooks

The Novas Coat Hook and Toilet Roll Holder (refer accessories) are specifically designed allowing for individual or co-ordinated applications.

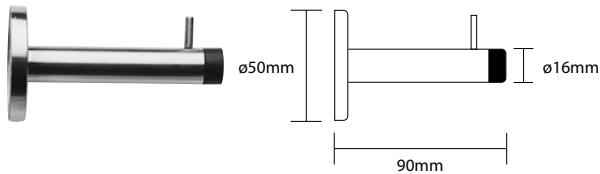

Coat Hook/Door Stop

Product Code 350301
Fixing Screw Fix
Finish SSS, PSS
Description Combination coat hook and door stop manufactured in Stainless Steel (304 grade). Features concealed screw mounting. Supplied with mounting screws.
Ordering Note Supplied standard in complete set.

Indicator

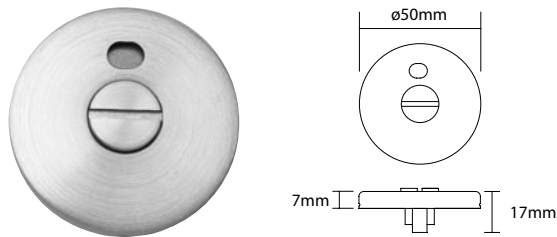

Indicator-Circular

Product Code 370501
Fixing Bolt Through
Finish SSS, PSS
Description Concealed stylish circular indicator that features bolt through fixing. Internationally recognised red/green indicator disc. Emergency release function. Manufactured in Stainless Steel (304 grade).

Ordering Ultima Partition Sets

Complete sets comprise of 1 pair concealed Gravity Hinges, Indicator, Turnbolt, Staple, Bumper, Hat and Coat Hook (options available). To order the correct hinge function and product options follow the simple chart.

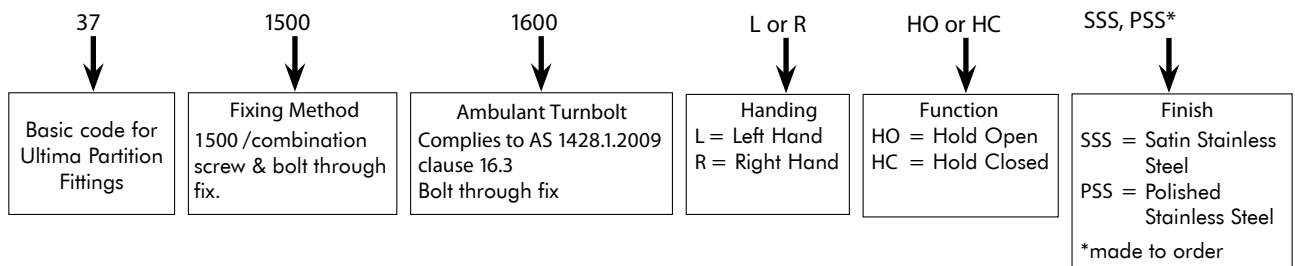

Example

If you wanted to order a kit with screw fixing, SSS gravity hinge, left-hand, hold open, your ordering number would be: 371500LHOSSS

Contact Details

Unit 4, 5 Becon Court,
Hallam Victoria 3803

P: 03 9709 3200
F: 03 9702 3595
E: sales@novas.com.au
W: www.novas.com.au



Meridian Series Complete Sets

About Meridian

- Meridian toilet partition fittings are appropriate for areas requiring superior appearance combined with streamlined and functional design.
- Meridian is suitable for the majority of high use areas including offices, shops and hotels.
- Meridian toilet partition fittings are primarily manufactured from Stainless Steel (304 grade) for ultimate durability, strength and sanitation.
- Complies with Building Code of Australia F2.5(B) Construction of Sanitary Compartments (using Novas 35-0601 or 35-0602).
- Fully integrated range to meet all fixing applications.
- Architecturally designed with clean lines and modern curves to integrate with today's styling.



NOTE: NOMINATE HANDING LH OR RH AND SETTINGS HOLD OPEN OR HOLD CLOSED WHEN ORDERING

Gravity Hinge Sets Bolt Through Fix

Product Code 352000

Components	350102	Gravity Hinge Bolt Fix
	350202	Bumper Bolt Fix
	350302	Coat Hook L Shaped Screw Fix
	350401	Turnbolt Screw Fix
	350501	Rectangular Indicator Concealed Fix
	350602	Z Staple Bolt Fix



Gravity Hinge Bolt Fix

Product Code	350102
Fixing	Bolt Fix
Finish	SSS
Description	Novas Gravity Hinge

NOTE: NOMINATE HANDING LH OR RH AND SETTINGS HOLD OPEN OR HOLD CLOSED WHEN ORDERING



Bumper Bolt Fix

Product Code	350202
Fixing	Bolt Fix
Finish	SSS
Description	Novas Bumper



NOVAS ARCHITECTURAL

Meridian Series Set Components



Coat Hook L Shaped Screw Fix

Product Code 350302
Fixing Screw Fix
Finish SSS
Description Novas coat hook L shaped



Turnbolt Screw Fix

Product Code 350401
Fixing Screw Fix
Finish SSS
Description Novas Turn Bolt Standard



Rectangular Indicator Concealed Fix

Product Code 350501
Fixing Concealed Fix
Finish SSS
Description Novas Indicator Rectangular



Z Staple Bolt Fix

Product Code 350602
Fixing Bolt Fix
Finish SSS
Description Novas Z Shaped Staple



Plenary Series Complete Sets

About Plenary

- Plenary toilet partition fittings are appropriate for areas requiring superior appearance combined with streamlined and functional design.
- Plenary is suitable for the majority of high use areas including offices, shops and hotels.
- Plenary toilet partition fittings are primarily manufactured from Stainless Steel (304 grade) for ultimate durability, strength and sanitation.
- Fully integrated range to meet all fixing applications.
- Architecturally designed with clean lines and modern curves to integrate with today's styling.



NOTE: NOMINATE HANDING LH OR RH AND SETTINGS HOLD OPEN OR HOLD CLOSED WHEN ORDERING

Gravity Hinge Sets Screw Fix

Product Code 361000

Components	360103	Gravity Hinge Screw Fix
	360206	Bumper Screw Fix
	360304	Coat Hook L Shaped Screw Fix
	360403	Centred T Turnbolt Screw Fix
	360505	Raised Rectangular Indicator Screw Fix
	360604	Z Staple Screw Fix



Gravity Hinge Screw Fix

Product Code	360103
Fixing	Screw Fix
Finish	SC
Description	Novas Gravity Hinge

NOTE: NOMINATE HANDING LH OR RH AND SETTINGS HOLD OPEN OR HOLD CLOSED WHEN ORDERING



Bumper Screw Fix

Product Code	360206
Fixing	Screw Fix
Finish	SC
Description	Novas Standard Bumper



NOVAS ARCHITECTURAL

Plenary Series Set Components



Coat Hook L Shaped Screw Fix

Product Code	360304
Fixing	Screw Fix
Finish	SC
Description	Novas Coat Hook L Shaped



Centred T Turnbolt Screw Fix

Product Code	360403
Fixing	Screw Fix
Finish	SC
Description	Novas Centred T Turnbolt



Raised Rectangular Indicator Screw Fix

Product Code	360505
Fixing	Screw Fix
Finish	SC
Description	Novas Raised Rectangular Indicator



Z Staple Screw Fix

Product Code	360604
Fixing	Screw Fix
Finish	SC
Description	Novas Z Staple



Apex Series Complete Sets

About Apex

- Apex toilet partition fittings are a sophisticated, stylish and durable collection for prestigious projects.
- Apex is ideally suited to prestige office and hotel environments where superior quality and design are demanded.
- Apex is primarily manufactured from stainless steel (304 grade) for ultimate durability, strength and sanitation.
- Complies with Building Code of Australia F2.5(B) Construction of Sanitary Compartments (using Novas 35-0601).
- Architecturally designed with clean lines and modern curves to integrate with today's styling.



NOTE: NOMINATE HANDING LH OR RH AND SETTINGS HOLD OPEN OR HOLD CLOSED WHEN ORDERING

Gravity Hinge Sets Concealed Fix

Product Code 363000

Components	360105	Gravity Hinge Concealed Fix
	360207	Bumper Concealed Fix
	360305	Coat Hook L Shape Concealed Fix
	360404	Turnbolt Concealed Fix
	360506	Circular Indicator Concealed Fix
	360605	Z Staple Concealed Fix

Pinnacle Series Complete Sets

NOTE:

- PINNACLE SERIES IS THE SAME AS APEX SERIES, BUT WITH 3 HINGES INSTEAD OF 2
- NOMINATE HANDING LH OR RH AND SETTINGS HOLD OPEN OR HOLD CLOSED WHEN ORDERING

Gravity Hinge Sets Concealed Fix

Product Code 363000

Components	360105	3 Gravity Hinges Concealed Fix
	360207	Bumper Concealed Fix
	360305	Coat Hook L Shape Concealed Fix
	360404	Turnbolt Concealed Fix
	360506	Circular Indicator Concealed Fix
	360605	Z Staple Concealed Fix





NOVAS ARCHITECTURAL

Apex & Pinnacle Series Set Components



Gravity Hinge Concealed Fix

Product Code 360105
Fixing Concealed Fix
Finish SC
Description Novas Gravity Hinge

NOTE: NOMINATE HANDING LH OR RH AND SETTINGS HOLD OPEN OR HOLD CLOSED WHEN ORDERING



Bumper Concealed Fix

Product Code 360207
Fixing Concealed Fix
Finish SC
Description Novas Bumper



Coat Hook L Shaped Concealed Fix

Product Code 360305
Fixing Concealed Fix
Finish SC
Description Novas Coat Hook L Shaped



Turnbolt Concealed Fix

Product Code 360404
Fixing Concealed Fix
Finish SC
Description Novas Turnbolt



Circular Indicator Concealed Fix

Product Code 360506
Fixing Concealed Fix
Finish SC
Description Novas Circular Indicator



Z Staple Concealed Fix

Product Code 360605
Fixing Concealed Fix
Finish SC
Description Novas Z Staple



Vertex Series Complete Sets

About Vertex

- Vertex toilet partition fittings are a flexible collection offering a variety of solutions to meet both cost and performance.
- Vertex is suitable for most commercial and educational applications.
- Vertex toilet partition fittings are manufactured from zinc die cast and stainless steel (304 grade) for ultimate durability, strength and sanitation.
- If specifying a lift-off facility we recommend that you use either Meridian, Plenary, Apex or Pinnacle series.



NOTE: NOMINATE SETTINGS HOLD OPEN OR HOLD CLOSED WHEN ORDERING

Spring Hinge Set

Product Code 365551

Components	360402	Offset T Turnbolt Screw Fix
	360504	Flat Face Rectangular Indicator Screw Fix
	360303	Coat Hook/Door Stop Screw Fix
	360606	L Shaped Staple Bolt Fix
	36905	Spring Hinge Bolt Fix
	360205	Bumper Bolt Fix



Spring Hinge Bolt Fix

Product Code	36905
Fixing	Bolt Fix
Finish	SSS
Description	Novas Spring Hinge



Offset T Turnbolt Screw Fix

Product Code	360402
Fixing	Screw Fix
Finish	SC
Description	Novas Offset T Turnbolt



NOVAS ARCHITECTURAL

Vertex Series Set Components



Flat Face Rectangular Indicator Screw Fix

Product Code	360504
Fixing	Screw Fix
Finish	SC
Description	Novas Flat Face Rectangular Indicator



Coat Hook/Door Stop Screw Fix

Product Code	360303
Fixing	Screw Fix
Finish	SC
Description	Novas Coat Hook/Door Stop



L Shaped Staple Bolt Fix

Product Code	360606
Fixing	Bolt Fix
Finish	SSS
Description	Novas L Shaped Staple



Bumper Bolt Fix

Product Code	360205
Fixing	Bolt Fix
Finish	SC
Description	Novas Bumper



Indicator Sets

Rectangular Indicator Set Screw Fix

Product Code 354000

Components 350501 Rectangular Indicator Concealed Fix
360401 Turnbolt Screw Fix
350602 Z Staple Bolt Fix



Raised Face Indicator Set Visible Screw Fix

Product Code 367000

Components 360505 Raised Rectangular Indicator Screw Fix
360403 Centred T Turnbolt Screw Fix
360604 Z Staple Screw Fix



Circular Indicator Set Concealed Bolt Fix

Product Code 368000

Components 360506 Circular Indicator Concealed Fix
360404 Turnbolt Concealed Fix
360605 Z Staple Concealed Fix



Circular Indicator Set Concealed Bolt Fix with Packer

Product Code 369000

Components 360506 Circular Indicator Concealed Fix
360404 Turnbolt Concealed Fix
360605 Z Staple Concealed Fix





Indicator Sets



Indicating Privacy Set with Screw On Cap

Product Code B11S

Components B09I Novas Indicating Emergency Release
Round B Rose
12907 Novas Tubular Deadbolt
B07 Novas Turnsnib Round B Rose



Indicating Privacy Set with Screw On Cap

Product Code B12S

Components B09I Novas Indicating Emergency Release
Round B Rose
12907 Novas Tubular Deadbolt
B06 Novas Turnsnib Round B Rose



Indicating Privacy Set with Screw On Cap

Product Code B13S

Components B09I Novas Indicating Emergency Release
Round B Rose
12907 Novas Tubular Deadbolt
B06D Novas Disabled Turnsnib Round B Rose



Accessories

Gravity Hinge Bolt Fix

Product Code 350102
Fixing Bolt Fix
Finish SSS
Description Novas Gravity Hinge



Gravity Hinge Screw Fix

Product Code 360103
Fixing Screw Fix
Finish SC
Description Novas Gravity Hinge



Gravity Hinge Concealed Fix

Product Code 360105
Fixing Concealed Fix
Finish SC
Description Novas Gravity Hinge



Spring Hinge Bolt Fix

Product Code 36905
Fixing Bolt Fix
Finish SSS
Description Novas Spring Hinge



Bumper Bolt Fix

Product Code 350202
Fixing Bolt Fix
Finish SSS
Description Novas Bumper



Bumper Edge Mounted Screw Fix

Product Code 350203
Fixing Screw Fix
Finish SSS
Description Novas Bumper Edge Mounted





Accessories



Bumper Bolt Fix

Product Code 360205
Fixing Screw Fix
Finish SC
Description Novas Bumper



Coat Hook/Door Stop

Product Code 350301
Fixing Concealed Fix
Finish SSS
Description Novas Coat Hook/Door Stop



Coat Hook L Shaped Screw Fix

Product Code 350302
Fixing Screw Fix
Finish SSS
Description Novas Coat Hook L Shaped



Coat Hook/Door Stop Screw Fix

Product Code 360303
Fixing Screw Fix
Finish SC
Description Novas Coat Hook/Door Stop



Coat Hook L Shaped Concealed Fix

Product Code 360304
Fixing Concealed Fix
Finish SC
Description Novas Coat Hook L Shaped



Turnbolt Screw Fix

Product Code 350401
Fixing Screw Fix
Finish SSS
Description Novas Turnbolt



Accessories

Rectangular Indicator Concealed Fix

Product Code 350501
Fixing Concealed Fix
Finish SSS
Description Novas Rectangular Indicator



U Staple Screw Fix

Product Code 350601
Fixing Screw Fix
Finish SSS
Description Novas U Staple



Z Staple Bolt Fix

Product Code 350602
Fixing Bolt Fix
Finish SSS
Description Novas Z Staple



Toilet Roll Holder

Product Code 350701
Fixing Screw Fix
Finish SSS
Description Novas Toilet Roll Holder



Adjustable Leg 200–250mm

Product Code 350801
Fixing Screw Fix
Finish SSS
Description Novas Adjustable Leg 200–250mm



Adjustable Leg 180–220mm

Product Code 350802
Fixing Screw Fix
Finish SSS
Description Novas Adjustable Leg 180–220mm





N O V A S A R C H I T E C T U R A L

Novas Toilet Partition Fittings

Novas Architectural is pleased to present an extensive collection of toilet partition fittings specifically designed to cater for all segments of the market. The toilet partition collections have earned a worldwide reputation for reliable high quality products, which have been installed throughout the UK, Middle East, Asia, New Zealand and Australia.

The design process backed by our team of engineers incorporates the key elements that drive the toilet partition market; aesthetics, durability, finish, cost competitiveness and ease of installation.

Materials

Novas Architectural Toilet Partition Fittings are manufactured from 304 grade Stainless Steel and Zinc Die Cast. Polished stainless steel and chrome plate are available upon request.

Hinge Handing

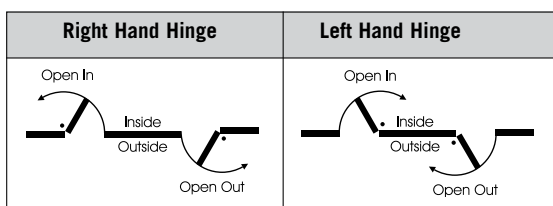

In all cases, the hand of the hinge must be related to two things, the direction the door opens and the side of the door on which the hinge knuckle is visible. Thus, a left hand door (open in) requires a left hand hinge. However, a left hand hinge is also required for a right hand reverse door (open out). Consequently the opposite applies for a right hand hinge (refer hinge handing above).

Always hand the hinge from the knuckle side of the door. eg. Hinges positioned to the left of the door, are left hand. Hinges positioned to the right of the door, are right hand.

Guarantee

Novas Architectural guarantee all their products against defects in workmanship and materials subject to inspection and confirmation of fair wear and tear within the normal working life of the product.

Novas Architectural assumes no liability for:

1. Improper installation or failure to follow fitting instructions.
2. Product failure due to improper maintenance or unfair wear and tear.
3. Indirect or consequential loss or damage.
4. Cost of removal and/or replacement.
5. Cost of freight and/or travelling expenses.
6. Some plated finishes are classified as soft finishes. Deterioration is possible under some climatic conditions and cannot be unconditionally guaranteed.

Consult your local Novas Architectural Representative or Agent for advice on all finishes.

Contact Details

Novas Architectural
Unit 4, 5-7 Becon Court,
Hallam, Victoria 3803.
Phone: 03 9709 3200
Fax: 03 9702 3595
Email: sales@novas.com.au
Web: www.novas.com.au